

Instruction Manual
ZEISS Stemi 305 cam
Stereo Microscope with Integrated Camera



ZEISS Stemi 305 cam

Original Manual



Carl Zeiss Microscopy GmbH
Carl-Zeiss-Promenade 10
07745 Jena
Germany
info.microscopy.de@zeiss.com
www.zeiss.com/microscopy

UK Importer

Carl Zeiss Ltd
1030 Cambourne Business Park, Cambourne
CB23 6DW Cambridge
United Kingdom



Carl Zeiss Suzhou Co., Ltd.
No. 26 Wusheng Road, SIP
215126 Suzhou
China

Document Name: ZEISS Stemi 305 cam

Order Number: 435063-7021-101

Revision: 2

Language: en-US

Effective from: 08/2024



© 2024 Without the prior written consent of ZEISS, this document or any part of it must neither be translated nor reproduced or transmitted in any form or by any means - including electronic or mechanic methods, by photocopying, recording or by any information or filing system. The right to make backup-copies for archiving purposes shall remain unaffected thereby. Any violations may be prosecuted as copyright infringements.

The use of general descriptive names, registered names, trademarks, etc. in this document does not imply that such names are exempt from the relevant intellectual property laws and regulations and therefore free for general use. This shall also apply if this is not specifically referred to. Software programs shall entirely remain the property of ZEISS. No program or subsequent upgrade thereof may be disclosed to any third party, copied or reproduced in any other form without the prior written consent of ZEISS, even if these copies or reproductions are destined for internal use at the customer's only, the only exception being one single back-up copy for archiving purposes.

Table of Contents

1	About this Instruction Manual	5
1.1	Text Conventions and Link Types	5
1.2	Explanation of Warning Messages and Additional Information	6
1.3	Explanation of Symbols	7
1.4	Further Applicable Documents	7
1.5	Contact	8
2	Safety	9
2.1	Intended Purpose	9
2.2	General Safety Information	9
2.2.1	Requirements for Operators	9
2.2.2	Safe Operating Condition	10
2.2.3	Order and Use of Spare Parts	10
2.2.4	EMC Information	10
2.2.5	Optical Risk Grouping	11
2.2.6	Lifetime	11
2.3	Prevention of Hazards	12
2.3.1	Hazards generated by Materials and Substances	12
2.4	Labels and Lights	12
2.4.1	Labels and Lights on the Stemi 305 cam Body	12
3	Product and Functional Description	14
3.1	Main Components of the Stemi 305 cam	14
3.2	Controls and Displays	15
3.3	Ethernet Operating Modes	15
3.4	Wi-Fi Operating Modes of the Stemi 305 cam	16
4	Installation	17
4.1	Connecting the Stemi 305 cam via Ethernet	17
4.2	Installing the Labscope Software	17
5	Operation	18
5.1	Prerequisites for Commissioning and Operation	18
5.2	Switching On the Ethernet DHCP	18
5.3	Acquiring an Image with Ethernet Connection to a LAN Network/Router	19
5.4	Acquiring an Image with Direct 1:1 Ethernet Connection to a Digital End Device	19
5.5	Connecting the Stemi 305 cam Via WLAN Access Point	20
5.6	Configuring Stemi 305 cam Via Labscope	21
5.6.1	Configuring the WLAN Access Point Modes	21
5.6.2	Configuring Connect to Existing WLAN Mode	23
5.6.3	Configuring the Ethernet DHCP Status	24
5.7	Acquiring an Image with WLAN Access Point Connection	24
5.8	Acquiring an Image with Connection to an Existing WLAN Network	25
5.9	Updating the Firmware of the Integrated Camera	26
5.10	Resetting the Microscope to Factory Settings	27

6	Care and Cleaning Work.....	28
6.1	Removing Water-Soluble Contamination	28
6.2	Cleaning an Optical Surface.....	29
7	Troubleshooting	30
8	Decommissioning and Disposal	33
8.1	Decommissioning	33
8.2	Transport and Storage.....	33
8.3	Disposal	33
8.4	Decontamination.....	34
9	Technical Data and Conformity	35
9.1	Performance Data and Specifications.....	35
9.2	Applicable Standards and Regulations	37
9.3	Radio Approval.....	38
10	Accessories and System Expansions	39
	Revision History.....	41
	Glossary.....	42
	Index	43

1 About this Instruction Manual

This Instruction Manual (further called "document") is considered to be part of the Stemi 305 cam, herein after referred to as "microscope".

In this instruction manual the Stemi 305 cam body is described. The document is valid only in conjunction with the main instruction manual Stemi 305. For more details refer to this instruction manual. Prevail to present instruction manual if any conflicts exist.

This document contains basic steps and safety information that must be observed during operation and maintenance. Therefore, the document must be read by the operator prior to commissioning and must always be available at the place of use of the microscope.

This document is an essential part of the microscope and, if the microscope is resold, the document must remain with the microscope or be handed over to the new owner.

1.1 Text Conventions and Link Types

Explanation	Example
Software controls and GUI elements.	Click Start .
Hardware controls and elements.	Press the Standby button.
Key on the keyboard.	Press Enter on the keyboard.
Press several keys on the keyboard simultaneously.	Press Ctrl + Alt + Del .
Follow a path in the software.	Select Tools > Goto Control Panel > Airlock .
Text to be entered by the user.	Enter <i>example.pdf</i> in this field.
Anything typed in literally during programming, for example macro codes and keywords.	Enter <code>Integer</code> in the console.
Link to further information within this document.	See: <i>Text Conventions and Link Types</i> [▶ 5].
Link to a website.	https://www.zeiss.com

1.2 Explanation of Warning Messages and Additional Information

DANGER, WARNING, CAUTION, and NOTICE are standard signal words used to determine the levels of hazards and risks of personal injury and property damage.

Always observe the safety and warning messages in **all** chapters of this document. Failure to comply with these instructions and warnings may result in personal injury, property damage, and the loss of any claims for damages.

The following warning messages indicating dangerous situations and hazards are used in this document.

DANGER

Type and source of danger

DANGER indicates an imminently hazardous situation which, if not avoided, will result in death or serious injury.

WARNING

Type and source of danger

WARNING indicates a potentially hazardous situation which, if not avoided, may result in death or serious injury.

CAUTION

Type and source of danger

CAUTION indicates a potentially hazardous situation which, if not avoided, may result in minor or moderate injury.

NOTICE













Type and source of danger

NOTICE indicates a potentially harmful situation which, if not avoided, may result in property damage.

Info

Provides additional information or explanations to help the user better understand the contents of this document.

1.3 Explanation of Symbols

	CE marking (Conformité Européene)
	UKCA marking (UK conformity assessed)
	Manufacturer
	Country of manufacture. "CC" is the country code, e.g. "DE" for Germany, "CN" for China. Date of manufacture optionally given adjacent to this symbol
	Importer
	Serial number
	Catalogue number
	WEEE label: Do not discard as unsorted waste. Send to separate collection facilities for recovery and recycling
	EFUP (Environmentally Friendly Use Period) of 50 years. According to the China RoHS regulation, it refers to the period during which the hazardous substances contained in an electronic or electrical product do not leak or mutate suddenly under normal operating conditions and will not result in serious environmental pollution or cause serious damage to the user's body or their assets during normal use.
	Approval mark for Japan Radio Law
	Model number
	Computer network
	Rated power input, d.c.

1.4 Further Applicable Documents

Brochures and Certificates For brochures, declarations of conformity, and other approval certificates ask your ZEISS Sales & Service Partner.

Local and National Health and Safety Regulations Observe local and national health and safety regulations for the location of installation and during the use of the microscope.

Consult with your ZEISS Sales & Service Partner if these regulations are in conflict with the installation requirements of the microscope.

- Safety Data Sheets** Observe the enclosed safety data sheets. The instructions and guidelines given in the respective safety data sheets must be complied with.
- System and Third-Party Components, Accessories** Information about the individual components, enhancements, and accessories can be obtained from your ZEISS Sales & Service Partner. Also refer to the documentation of third-party manufacturers.
- Software** For detailed information on how to use Labscope, refer to its manual (e.g. Online Help, Software Manual) or ask your ZEISS Sales & Service Partner.
- Instruction Manuals** Also observe the following instruction manuals:
- Labscope software
 - Alternative Stemi stands (Stand M LED, Stand U, Boom Stand B, Stand SDA, Floor Stand S)

1.5 Contact

If you have any questions or problems, contact your local ZEISS Sales & Service Partner or one of the following addresses:

Headquarters

Phone: +49 1803 33 63 34

Fax: +49 3641 64 3439

Email: info.microscopy.de@zeiss.com

Microscopy Courses, Training, and Education

For information on microscopy courses, training, and education visit the ZEISS Academy Microscopy (<https://www.zeiss.com/microscopy/en/service-support/training-education/academy-microscopy.html>).

ZEISS Portal

The ZEISS Portal (<https://portal.zeiss.com/>) offers various services that simplify the daily work with your ZEISS systems (machines and software).

Service Germany

Phone: +49 7364 20 3800

Fax: +49 7364 20 3226

Email: service.microscopy.de@zeiss.com

2 Safety

This chapter contains general requirements for safe working practices. Any person using the microscope or commissioned with installation or maintenance must read and observe these general safety instructions. Knowledge of basic safety instructions and requirements is a precondition for safe and fault-free operation. Operational safety of the supplied microscope is only ensured if it is operated according to its intended use.

If any work is associated with residual risks, this is mentioned in the relevant parts of this document in a specific note. When components must be handled with special caution, they are marked with a warning label. These warnings must always be observed.

Improper use of the microscope and its components can easily lead to impairment of their function or even damage them. Damage caused by incorrect operation, negligence, or unauthorized intervention, in particular by removing, modifying, or replacing parts of the microscope or its components, cannot be held liable by the device manufacturer. Third-party devices or components that are not expressly approved by ZEISS may not be used.

Any serious incident that has occurred in relation to the microscope and its components shall be reported to these institutions:

- the competent authority of the Member State in which the user is established
- Carl Zeiss Suzhou Co., Ltd., Suzhou, China

2.1 Intended Purpose

The stereo microscope Stemi 305 cam is an instrument for the general magnifying, spatial imaging of small objects. The microscope is designed and built for use in biological laboratories, industrial manufacturing and quality assurance and is used for observing, preparing and sorting objects and specimens of various types and conditions. It is not intended to either directly or indirectly generate medical diagnostic results.

2.2 General Safety Information

This document and the main instruction manual for Stemi 305 must be read before commissioning in order to ensure safe and uninterrupted operation. Pay particular attention to all listed safety notes. Make sure, that

- the operating personnel has read and understood this manual, associated documents and particularly all safety regulations and instructions, and applies them.
- the local and national safety and accident prevention regulations must be observed, as well as the applicable laws and regulations in your country.
- this document is always available at the place of use of the microscope.
- the microscope is always in perfect condition.
- in case of defect or damage, the affected parts and the microscope are taken out of operation immediately and are secured against unintentional use.
- maintenance and repair work, retrofitting, removal or replacement of components, as well as any other intervention in the microscope not described in this document, may only be carried out by the manufacturer ZEISS or persons expressly authorized by ZEISS to do so.

2.2.1 Requirements for Operators

The microscope, components, and accessories may only be operated and maintained by authorized and trained personnel. The microscope may only be used in accordance with this document. If the microscope is not used as described, the safety of the user may be impaired and/or the microscope may be damaged.

Any unauthorized intervention or use other than within the scope of the intended use shall void all rights to warranty claims. The regional regulations on health protection and accident prevention must be observed at all times and during all work on and with the microscope.

2.2.2 Safe Operating Condition

If circumstances occur which impair safety and cause changes in operating behavior, the microscope and its components must be shut down immediately and a ZEISS service representative should be informed.

The microscope may only be operated if the operating conditions are adhered to.

- Do not operate the microscope and its components until you have completely read and understood the entire documentation.
- Make sure that all protective cover panels are installed and all warning labels are available and legible.
- Ensure conditions and take measures to prevent the build up of electrostatic charge on the workplace.

2.2.3 Order and Use of Spare Parts

Using spare parts that are not provided by ZEISS can be hazardous or can lead to property damage.

- Unless authorized by ZEISS, all spare parts should be installed by a ZEISS service representative.
- Contact your ZEISS service representative for information on spare parts order.
- Only genuine parts supplied by ZEISS are to be used in servicing the microscope and its components.

2.2.4 EMC Information

The microscope is intended to be used in a basic electromagnetic environment.

The microscope complies with the emission and immunity requirements as a CISPR 11 / EN 55011 / class A group 1 system according to IEC 61326-1. Emissions, which exceed the levels required by CISPR 11 / EN 55011, can occur when the microscope is connected to other devices.

This device complies with Part 15 of the FCC Rules. Operation is subject to the following two conditions:

- (1) this device may not cause harmful interference, and
- (2) this device must accept any interference received, including interference that may cause undesired operation.

The following EMC user notice is for Canada only:

This device complies with CAN ICES-003 (B)/NMB-003(B).

Please take attention that changes or modification not expressly approved by the party responsible for compliance could void the user's authority to operate the equipment.

This device complies with Industry Canada licence-exempt RSS standard(s). Operation is subject to the following two conditions:
 (1) this device may not cause interference, and
 (2) this device must accept any interference, including interference that may cause undesired operation of the device.

Le présent appareil est conforme aux CNR d'Industrie Canada applicables aux appareils radioexempts de licence. L'exploitation est autorisée aux deux conditions suivantes :
 (1) l'appareil ne doit pas produire de brouillage, et
 (2) l'utilisateur de l'appareil doit accepter tout

brouillage radioélectrique subi, même si le brouillage est susceptible d'en compromettre le fonctionnement.

2.2.5 Optical Risk Grouping

According to IEC 62471 sources of optical radiation are classified into risk groups subject to their potential photobiological hazard. Sources are classified into the following four groups according to hazard, based on the emission limit as well as permissible exposure time before hazard exceeded.

Risk group	Description
Exempt	No photobiological hazard.
1	No hazard due to normal behavioural limitations on exposure.
2	No hazard due to the aversion response to very bright light sources or thermal discomfort.
3	Hazardous even for momentary exposure.

The following table lists the risk grouping of the available light sources/illumination units according to the mentioned standard:

Light source/Illumination unit	Risk group
Overall device	2 (moderate risk)
Integrated vertical illumination	2 (moderate risk)
Spot illuminator K LED (reflected illumination)	2 (moderate risk)
Double spot illuminator K LED (reflected illumination)	2 (moderate risk)
Transmitted-light unit in stand K LAB	2 (moderate risk)
Transmitted-light unit in stand K EDU	2 (moderate risk)
Ring illuminator K-LED	2 (moderate risk)

2.2.6 Lifetime

A microscope is an opto-electronic device. Its availability for use is significantly determined by the performed maintenance. ZEISS guarantees the ability for maintenance and repair within eight years after initial operation. This is ensured by a corresponding service and spare parts concept, thus enabling the intended purpose within this duration.

2.3 Prevention of Hazards

This section summarizes potential hazards and recommended safety precautions. Failure to follow the safety instructions and instructions may result in personal injury and property damage.

2.3.1 Hazards generated by Materials and Substances

Dirt, Dust, and Moisture

Dirt, dust, and moisture can impair the microscope's functionality.

- Shut down the microscope whenever it is not used and cover it with a dust protection cover.
- Always cover unused openings/ports with the corresponding system component or with blind caps.
- Perform regular maintenance and cleaning according to the instructions in this manual.
- Make sure that no cleaning liquid or moisture gets inside the microscope.
- Make sure that the electrical parts never come into contact with moisture.
- Never expose the microscope to inadmissible climate conditions (high humidity and temperature).

2.4 Labels and Lights

This chapter shows labels and, where applicable, indicator lights.

All parts that may pose specific hazards are marked with warning labels.

Always observe **all** warning labels!

- Check all warning labels for availability and legibility.
- Immediately replace damaged or illegible warning labels.

In case a label is missing, contact your ZEISS service representative for free of charge replacement.

2.4.1 Labels and Lights on the Stemi 305 cam Body

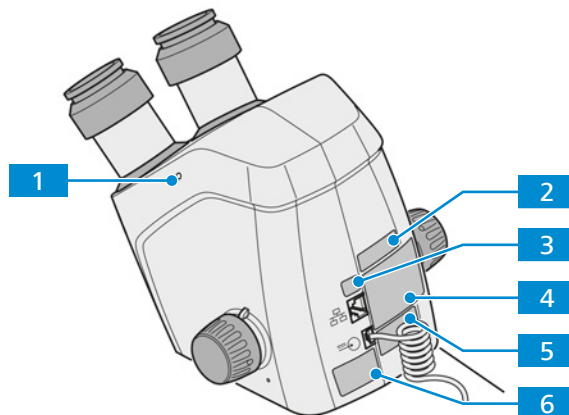
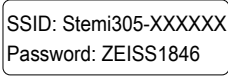

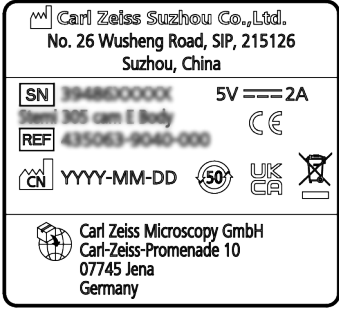

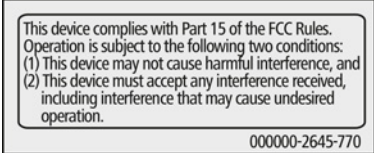

Fig. 1: Labels and light on the Stemi 305 cam body

Pos.	Label/Light	Explanation
1	LED status: continuously blue	Integrated camera is ready for operation.
2		<p>only applicable for Stemi 305 cam W body: Wi-Fi identifier label</p> <p>SSID: Stemi305-XXXXXX Password: ZEISS1846</p>
3		<p>Only for Ethernet!</p> <p>Indicates that the marked socket is only to be used for the RJ45 Ethernet cable.</p>
4		Type label for Stemi 305 cam body
5		<p>only applicable for Stemi 305 cam W body: Wi-Fi certification label</p>
6		<p>only applicable for Stemi 305 cam W body: FCC warning label</p> <p>This device complies with Part 15 of the FCC Rules. Operation is subject to the following two conditions: (1) This device may not cause harmful interference, and (2) This device must accept any interference received, including interference that may cause undesired operation.</p>

3 Product and Functional Description

The Stemi 305 cam stereo microscopes with integrated camera are designed for magnifying spatial observation of small objects. Additionally, they allow visualization of the objects in a live image on the monitor and recording of digital images and videos.

The visualized images of the Stemi 305 cam may only be used for documentation, laboratory and research purposes. The images are not intended for the direct generation of diagnostic results.

With the Stemi 305 cam stereo microscopes, the digital images from the integrated camera can be transmitted via digital networks or transferred directly "one-to-one" to digital end devices (PC, laptop, tablet computer, etc.).

The Stemi 305 cam is available in two versions:

- Stemi 305 cam W body with integrated Wi-Fi and Ethernet camera can transfer digital images both wirelessly and wired. Stemi 305 cam W body is only available in certain countries for which it has radio license .
- Stemi 305 cam E body with Ethernet camera (without Wi-Fi function) is available worldwide. The transmission of digital images is only possible via a cable-based Ethernet network.

3.1 Main Components of the Stemi 305 cam

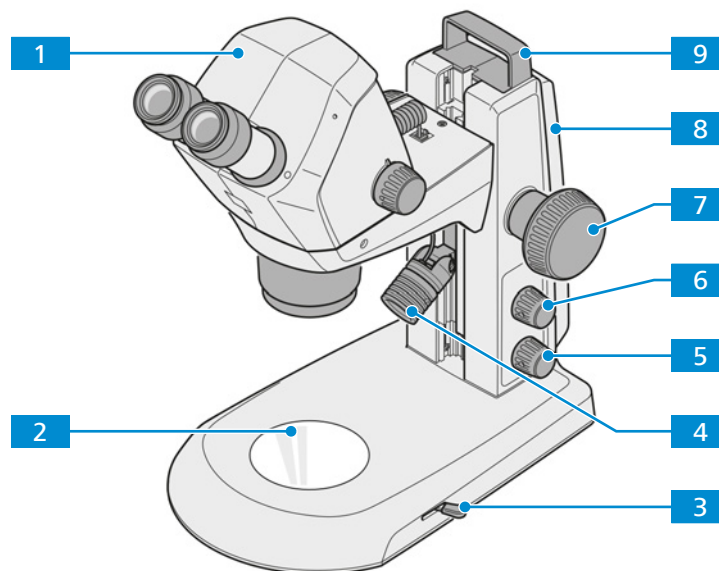

Fig. 2: Main components of Stemi 305 cam

- | | |
|---|--|
| 1 Stemi 305 cam <i>body</i> [▶ 15] | 2 Insert plate |
| 3 Lever | 4 Reflected-light illumination (spot illuminator K LED) |
| 5 Rotary/push-button | 6 Rotary/push-button |
| 7 Focusing drive | 8 Stand (model K EDU) |
| 9 Handle | |

3.2 Controls and Displays

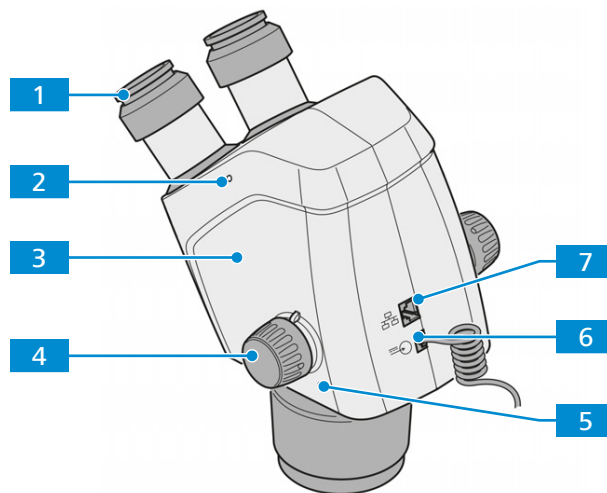

Fig. 3: Controls and displays of the Stemi 305 cam body

- | | |
|----------------------------|--|
| 1 Eyepiece (10x/23) | 2 Status LED [▶ 12] |
| 3 Microscope body | 4 Zoom button |
| 5 Reset opening | 6 RJ12 port with spiral cable |
| 7 Ethernet port | |

3.3 Ethernet Operating Modes

The Stemi 305 cam W body and the Stemi 305 cam E body newly add one Ethernet port to establish a wired connection and provide the following operating modes:

Operating mode	Description
Connect to LAN network	<p>This is the default Ethernet wired connection mode.</p> <p>Several Stemi 305 cam can be integrated into an existing network using Ethernet. For this purpose, the Ethernet socket of each Stemi 305 cam is connected to a network router or network switch via an Ethernet cable. In the Labscope app, the live images of all connected microscopes are displayed as thumbnails with any digital end device in the network and each camera can be accessed.</p> <p>This mode requires that Ethernet DHCP status should be off.</p>
Direct 1:1 LAN connection	<p>A single Stemi 305 cam can be connected directly (1:1) to the Ethernet port of a digital end device via an Ethernet cable. In the Labscope app, the live image of Stemi 305 cam is recognized and comfortable access to the camera is established.</p> <p>This mode requires that Ethernet DHCP status should be on.</p>

3.4 Wi-Fi Operating Modes of the Stemi 305 cam

Except for Ethernet operation mode, the Stemi 305 cam W body provides the following additional operation modes through wireless connection:

Operating mode	Description
WLAN access point	<p>This is the default wireless mode of the Stemi 305 cam W body.</p> <p>In this mode, each Stemi 305 cam W microscope provides its own Wi-Fi network with individual Wi-Fi SSID.</p> <p>In this mode, digital end devices (computers, tablets or smartphones) can connect wirelessly to the integrated camera and use Labscope to view the live stream under a maximum resolution of 1920x1080 pixels, take pictures or record videos.</p>
Connect to existing WLAN	<p>In this mode, Stemi 305 cam W body connects to an existing Wi-Fi network.</p> <p>Multiple Stemi 305 cam W body can be integrated into any existing Wi-Fi network. In this mode, any digital end device (computer, tablet or smartphone) in the Wi-Fi network using Labscope can view the live images of all connected microscopes as thumbnails and access each camera easily and conveniently.</p>

4 Installation

For further information on installation, refer to the instruction manual Stemi 305.

4.1 Connecting the Stemi 305 cam via Ethernet

NOTICE

Risk of electronics damage

Only an Ethernet cable with RJ45 plug may be connected to the Ethernet socket. It may only be used to connect to a LAN network or a digital end device via Ethernet. Connecting any other cable (incl. the RJ12 power cable of a stand K/M or controller K) can damage the Ethernet electronics of the Stemi 305 cam body.

Prerequisite ✓ The Stemi 305 cam body is attached to the microscope stand.

- Procedure**
1. Remove the cover from the camera's Ethernet port.
 2. Insert the Ethernet cable into the camera's Ethernet port.

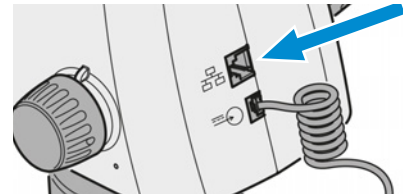

3. Insert the other end of the Ethernet cable into a LAN port on the network router or into the Ethernet port of the digital end device.

4.2 Installing the Labscope Software

- For Windows**
1. Scan the QR code to download the latest version of the Labscope software.



- You will be directed to the ZEISS portal for downloading the installation files.
 2. Select the appropriate operating system and start the download.
 3. Perform the required steps shown by the installation wizard.
 4. If asked, agree to install additional drivers.
- ↳ After the installation the Labscope program icon is shown on your tablet PC.

More information can be found in the Labscope instruction manual.

For iOS® The Labscope apps for iOS® can be downloaded via the App Store®.

Refer to the product website <https://www.zeiss.com/labscope> for further information.

5 Operation

This chapter describes switching on/off the microscope as well as the operating steps with the microscope.

Info

For additional information and detailed descriptions, refer to further applicable documents or ask your ZEISS Sales & Service Partner.

Info

Further information on the software and its operation is available in the software's online help.

5.1 Prerequisites for Commissioning and Operation

The following basic prerequisites are necessary for commissioning and operation:

- This document was read prior to commissioning or operation and kept for further use.
- The chapter **Safety** was read and understood.
- The operator is acquainted with the general Windows-based programs.
- If required: Basic training and safety briefing were successfully completed.

5.2 Switching On the Ethernet DHCP

Info

Alternatively, DHCP can be switched on and off using the **Labscope software** [[▶ 24](#)].

In the factory setting, the DHCP is switched off.

- Procedure**
1. Insert a bent paper clip or a needle into the reset hole.

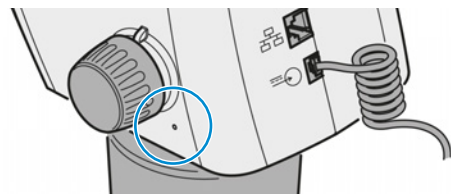

2. Press the reset button shortly until it clicks audibly.
→ The status LED blinks once.
3. Switch the microscope off and on again using the power switch.
→ The integrated camera restarts with the Ethernet DHCP status on.

5.3 Acquiring an Image with Ethernet Connection to a LAN Network/Router

- Prerequisite**
- ✓ A digital end device with the software **Labscope** is available and has already been started.
 - ✓ Stemi 305 cam is *connected to the LAN network/router via Ethernet cable* [▶ 17].
 - ✓ The digital end device is connected to the same LAN network/router.
 - ✓ The Ethernet DHCP status of Stemi 305 cam is off.

- Procedure**
1. Start the **Labscope** app on the digital end device by clicking on the **Labscope** icon.
 - The Labscope page **Microscopes View** opens.
 - The four thumbnails of the virtual live images are displayed.
 2. Switch on the microscope.
 3. Wait until the status LED lights up continuously.
 4. Wait until the Ethernet connection between microscope and the digital end device is established.
 - The thumbnail of the Stemi 305 cam is displayed.

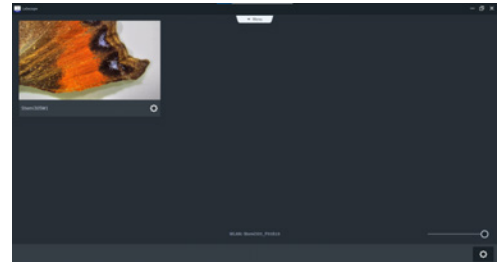

5. Click on the center of the thumbnail.
 - The live image appears enlarged on the screen.
6. Vary the zoom, the focus position, or the brightness setting of the microscope until a smooth live image is displayed.

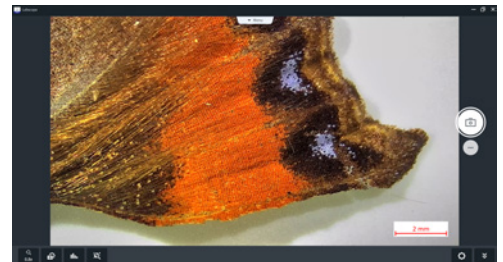

7. Press the snap icon to acquire the image.

5.4 Acquiring an Image with Direct 1:1 Ethernet Connection to a Digital End Device

- Prerequisite**
- ✓ A digital end device with the software **Labscope** is available and has already been started.
 - ✓ Stemi 305 cam is *connected to the digital end device via Ethernet cable* [▶ 17].
 - ✓ The Ethernet DHCP status of Stemi 305 cam is on.

- Procedure**
1. Start the **Labscope** app on the digital end device by clicking on the **Labscope** icon.
 - The Labscope page **Microscopes View** opens.
 - The four thumbnails of the virtual live images are displayed.
 2. Switch on the microscope.
 3. Wait until the status LED lights up continuously.
 4. Wait until the Ethernet connection between microscope and the digital end device is established.

- The thumbnail of the Stemi 305 cam is displayed.

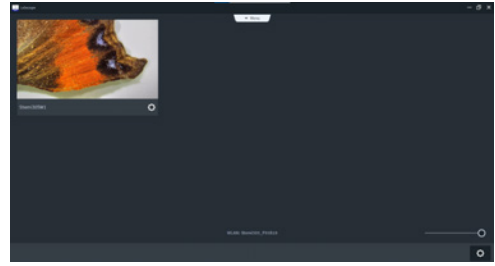

5. Click on the center of the thumbnail.
→ The live image appears enlarged on the screen.
6. Vary the zoom, the focus position, or the brightness setting of the microscope until a smooth live image is displayed.

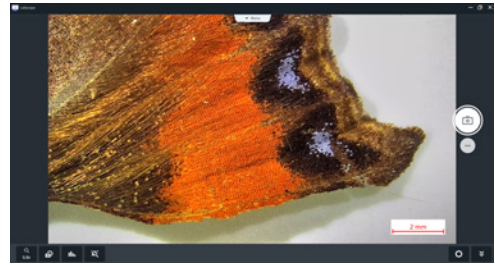

7. Press the snap icon to acquire the image.

5.5 Connecting the Stemi 305 cam Via WLAN Access Point

- Prerequisite**
- ✓ The Stemi 305 cam W body is attached to the microscope stand.
 - ✓ The microscope is operational.
 - ✓ **Labscope** is installed [▶ 17] on the digital end device.

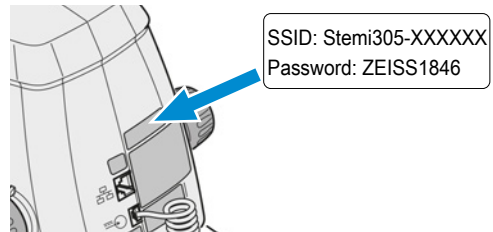

- Procedure**
1. Switch on the microscope.
 2. Wait until the status LED lights up continuously.
→ The camera provides a WLAN access point.
 3. In the network settings of the digital end device, select the default **Wi-Fi SSID** of the Stemi 305 cam network **Stemi305-XXXXXX**.



4. Enter the default password ZEISS1846.
5. On the digital end device, open **Labscope**.
→ **Labscope** recognizes the camera automatically.

5.6 Configuring Stemi 305 cam Via Labscope

- Prerequisite**
- ✓ The microscope is operational.
 - ✓ A digital end device with the software **Labscope** is connected to the network and has already been started.
 - ✓ The thumbnail of the live image is displayed.

- Procedure**
1. Click on the live image.
 - The **Live** view page is displayed.
- 
2. Click on the  button.
 - The **Camera Acquisition settings** window opens.
 3. Click on the **Advanced** tab.
 4. Click on the link **WLAN configuration web-interface**.
 - The internet browser of the digital end device opens.
 5. Enter the user name `admin` and the password `ZEISS1846`.
 6. Click **Sign in**.
 - The browser tab **Stemi 305 cam WLAN configuration** opens.

5.6.1 Configuring the WLAN Access Point Modes

NOTICE

Unauthorized access to the WLAN network

It is recommended to change the default password via the WLAN configuration website. When choosing the new WLAN password, make sure that the password contains upper and lower case letters, digits, hyphens or underscores and is reasonably long (recommendation: at least 10 digits), e.g. TP-Link_02_4G. Dots and other special characters are not allowed.

- Prerequisite**
- ✓ The Stemi 305 cam W body is attached to the microscope stand.
 - ✓ The browser tab **Stemi 305 cam WLAN configuration** is opened on the digital end device.

- Procedure**
1. Select **As Access Point** and confirm with **Next**.

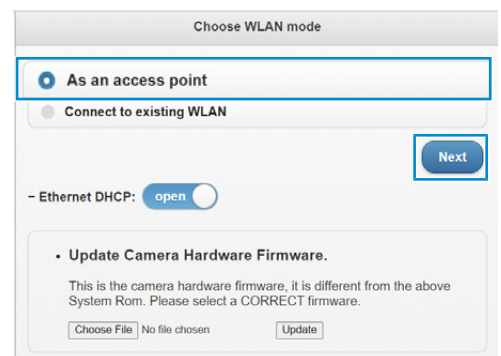

- The Wi-Fi SSID and password of the network provided by Stemi 305 cam are displayed.

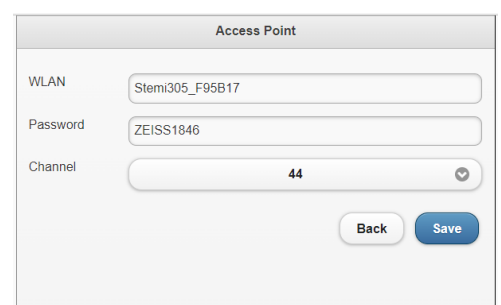

- If required, change the Wi-Fi SSID (**WLAN**).

The screenshot shows the 'Access Point' configuration interface. The 'WLAN' field is highlighted with a blue border, indicating it is the current step in the configuration process. The 'Password' and 'Channel' fields are also visible but not highlighted. 'Back' and 'Save' buttons are at the bottom right.

- If required, change the **Password**.

The screenshot shows the 'Access Point' configuration interface. The 'Password' field is highlighted with a blue border. The 'WLAN' and 'Channel' fields are visible but not highlighted. 'Back' and 'Save' buttons are at the bottom right.

- If required, change the **Channel**.
Wi-Fi channels 1-11 are in the 2.4 GHz band.
The higher channel numbers are in the 5 GHz band.

The screenshot shows the 'Access Point' configuration interface. The 'Channel' dropdown menu is highlighted with a blue border. The 'WLAN' and 'Password' fields are visible but not highlighted. 'Back' and 'Save' buttons are at the bottom right.

- To confirm, click **Save**.

The screenshot shows the 'Access Point' configuration interface. The 'Save' button is highlighted with a blue border, indicating the final step in the configuration process. The 'WLAN', 'Password', and 'Channel' fields are visible but not highlighted. 'Back' and 'Save' buttons are at the bottom right.

- Close the browser tab.
- Wait until the status LED lights up continuously.

↳ Stemi 305 cam provides its own WLAN network with the newly selected SSID, password and transmission channel.

5.6.2 Configuring Connect to Existing WLAN Mode

- Prerequisite**
- ✓ The Stemi 305 cam W body is attached to the microscope stand.
 - ✓ The browser tab **Stemi 305 cam WLAN configuration** is opened on the digital end device.

- Procedure**
1. Select **Connect to existing WLAN** and confirm with **Next**.

2. Select the required **WLAN** network.
NOTICE Only WLAN networks with names in Latin letters can be found.

3. Enter the **Password**.

4. To confirm, click **Save**.

5. Close the browser tab.
6. Wait until the status LED lights up continuously.
 → Stemi 305 cam is connected to the existing WLAN network.
7. If required, repeat the previous steps for additional Stemi 305 cam.

5.6.3 Configuring the Ethernet DHCP Status

- Prerequisite** ✓ The Stemi 305 cam body is attached to the microscope stand.
 ✓ The browser tab **Stemi 305 cam WLAN configuration** is opened on the digital end device.

- Procedure** 1. Set **Ethernet DHCP** to **open** to connect the Stemi 305 cam directly to a digital end device. Set **Ethernet DHCP** to **close** to connect the Stemi 305 cam to a LAN network via network router.

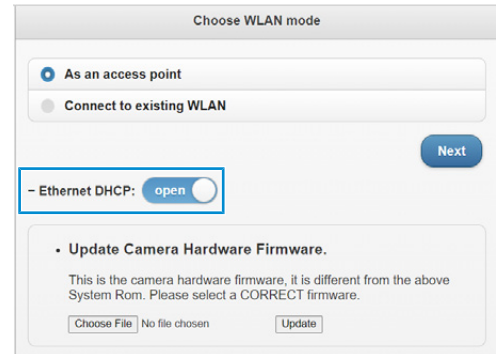

2. Switch the microscope off and on again using the power switch.
 3. Close the browser tab.
 4. Wait until the status LED lights up continuously.
 ↳ Stemi 305 cam has started with switched DHCP status.

5.7 Acquiring an Image with WLAN Access Point Connection

- Prerequisite** ✓ A digital end device with the software **Labscope** is connected to the WLAN access point of Stemi 305 cam [▶ 20] and has already been started.

- Procedure** 1. Start the **Labscope** app on the digital end device by clicking on the **Labscope** icon.
 2. Switch on the microscope.
 3. Wait until the status LED lights up continuously.
 4. Wait until the wireless connection between microscope and the computer is established.
 → The thumbnail of the Stemi 305 cam is displayed.

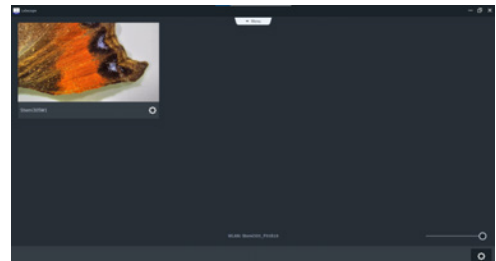

5. Click on the center of the thumbnail.
 → The live image appears enlarged on the screen.
 6. Vary the zoom, the focus position, or the brightness setting of the microscope until a smooth live image is displayed.

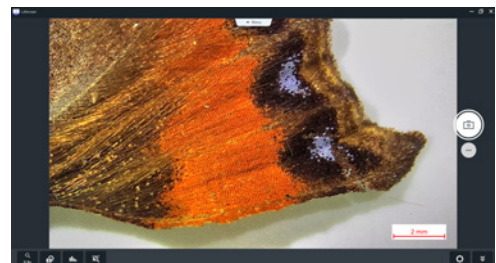

7. Press the snap icon to acquire the image.

5.8 Acquiring an Image with Connection to an Existing WLAN Network

- Prerequisite**
- ✓ An existing WLAN network is available and already running.
 - ✓ A digital end device with the software **Labscope** is connected to this network and has already been started.
 - ✓ Stemi 305 cam W body is connected to this network through the *configuration steps* [▶ 23].

- Procedure**
1. Start the **Labscope** app on the digital end device by clicking on the **Labscope** icon.
 2. Switch on the microscope.
 3. Wait until the status LED lights up continuously.
 4. Wait until the wireless connection between microscope and the computer is established.
 - ➔ The thumbnail of the Stemi 305 cam is displayed.

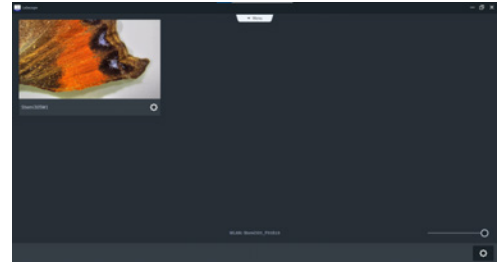

5. Click on the center of the thumbnail.
 - ➔ The live image appears enlarged on the screen.
6. Vary the zoom, the focus position, or the brightness setting of the microscope until a smooth live image is displayed.

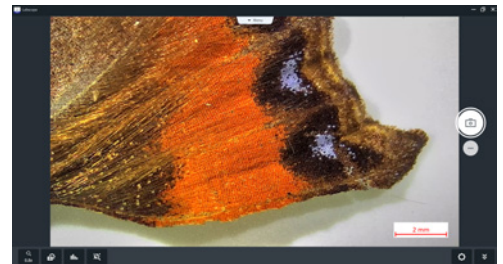

7. Press the snap icon to acquire the image.

5.9 Updating the Firmware of the Integrated Camera

NOTICE

Malfunction due to wrong software version

Take care to download the correct firmware file according to the existing Stemi 305 cam body.

- Prerequisite**
- ✓ The latest firmware has been downloaded from the ZEISS web page and is available on the digital end device.
 - ✓ The browser tab **Stemi 305 cam WLAN configuration** is opened on the digital end device.

- Procedure**
1. Click **Choose file**.

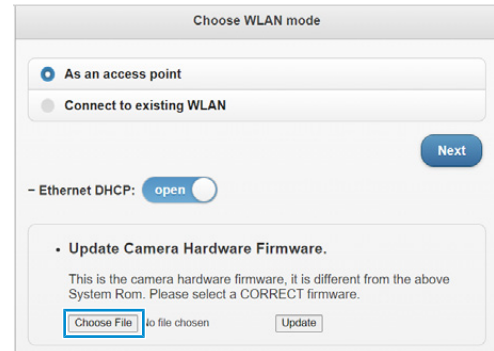

- The **Windows Explorer** opens.
2. Select the new firmware file **Stemi305_X_vX.tar.gz..**
 3. Click **Update**.

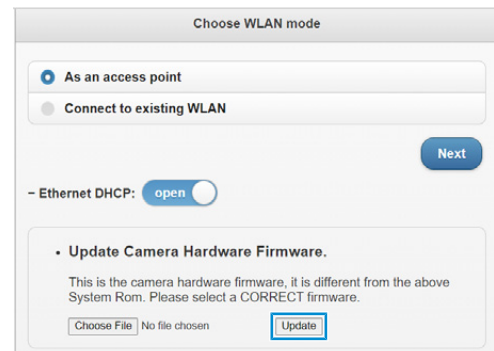

- After some seconds, a new browser tab opens displaying **success**.
 - The status LED turns off
4. Wait until the status LED lights up continuously.
 - The update is finished.
 5. Close the browser tab.

5.10 Resetting the Microscope to Factory Settings

NOTICE

Use this function with caution as it will reset all existing configurations.

The default factory settings are:

- The Ethernet DHCP status is off.
- The Ethernet port only allows **Connect to LAN network** mode
- Stemi 305 cam W body is in **WLAN Access Point** mode.
- The WLAN identifier (SSID and password) are set to the values given on the label on the microscope body.
- All stored configurations are cleared.

- Prerequisite**
- ✓ The microscope is operational.
 - ✓ The status LED lights up continuously.

- Procedure**
1. Insert a bent paper clip or a needle into the reset hole.

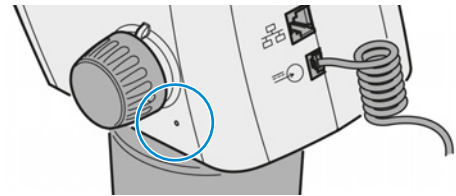

2. Press the reset button until it clicks audibly for at least ten seconds.

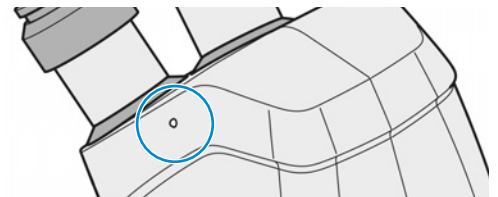

→ The status LED blinks twice, the resetting progress is starting.

- ↳ When the status LED lights up continuously, the reset to the default factory setting is successful.

6 Care and Cleaning Work

To ensure the best possible performance of the microscope and its components, maintenance must be performed on a regular basis. Keep the service logs of the microscope.

To maintain operational safety and reliability of the microscope, we recommend entering into a **ZEISS Protect Service Agreement**.

DANGER

Electric injury due to live parts

When the microscope and its components are still switched on, coming in contact with live parts can lead to electric shock or burn.

- ▶ Switch off the microscope and its components prior to opening or cleaning.
- ▶ Disconnect live parts from the power supply.

NOTICE

Functional impairment due to dirt and moisture

Dirt, dust, and moisture can impair the microscope functionality and can cause short-circuits.

- ▶ Use the dust protection cover if the microscope is not used.
- ▶ The ventilation slots must be unobstructed at all times.
- ▶ Perform regular maintenance and cleaning according to the instructions in this document and according to the instructions in the applicable documents.
- ▶ Make sure that no cleaning liquid or moisture gets inside the microscope and its components.
- ▶ In case of damage, the affected parts of the microscope must be taken out of operation.

6.1 Removing Water-Soluble Contamination

- Parts and Tools**
-  Clean cloth
 -  Lint-free cloth

- Prerequisite**  The microscope and its components are switched off and disconnected from the power supply.

- Procedure**
1. Remove dust and loose dirt particles with a soft brush or clean lint-free cloth.
 2. If necessary, moisten a clean cloth with water.
 - Stubborn dirt can be cleaned with all commercially available water solutions, benzine or alcohol (no solvent!). For cleaning coated parts, use a linen or leather cloth that is moistened with one of these substances.
 - Info** Labels on the device may only be cleaned using a dry cloth.
 3. Wipe off the area with the cloth.
 4. Dry with a lint-free cloth.

6.2 Cleaning an Optical Surface

NOTICE

Damage of optical surfaces due to improper cleaning

- ▶ Remove dust from the optical surface slowly and carefully.
- ▶ Remove dust on optical surfaces with a natural-hair brush or blow it off with a rubber bellows.
- ▶ Avoid touching optical surfaces with fingers.

- Parts and Tools**
- 🔧 Clean cloth
 - 🔧 Cotton swab
 - 🔧 Distilled water
 - 🔧 Optical cleaning solution (70 % ethanol)
 - 🔧 Lint-free cloth

- Procedure**
1. Moisten a cotton swab or a clean cloth with distilled water or, if necessary, with an optical cleaning solution.
 2. Wipe optical surfaces in a circular motion towards the edge of the optics with slight pressure.

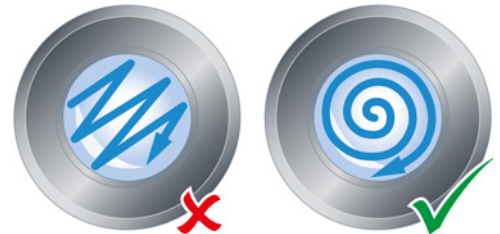

3. Dry with a lint-free cloth.

7 Troubleshooting

The following table provides information about solving common problems.

Info

If you cannot solve the problem or if you are unsure about a certain technical difficulty, contact your local ZEISS service representative.

Symptom	Cause	Measure
Stereo microscope illumination cannot be switched ON.	No mains power.	Check and establish mains power.
	Power cord not connected correctly to the power supply unit or defective.	Correctly connect - or exchange – the mains cable.
	Power supply unit not correctly connected to microscope electronics or defective	<ul style="list-style-type: none"> ▪ Correctly connect the DC cable of the power supply unit to the microscope (inside stand column). ▪ Check intactness of the power unit. In doubt, replace it acc. to operating manual "Stemi 305"
	Microscope not switched ON.	Turn the power switch on the back of the microscope stand ON.
Microscope illumination works, but the status LED does not light up.	RJ12 spiral cable between microscope body and stand not connected or defective.	Correctly connect or change the RJ12 spiral cable between microscope body and stand.
The status LED lights up continuously, but the live image is not recognized in a digital end device with Labscope.	Stemi 305 cam is not connected to the digital end device.	<ul style="list-style-type: none"> ▪ Connect Stemi 305 cam directly to the digital end device via Ethernet or Wi-Fi. ▪ Connect Stemi 305 cam and the digital end device to the same network.
	Labscope is not updated.	Download and install actual version of Labscope.
	Unspecific camera behaviour.	<i>Reset Stemi 305 cam</i> [▶ 27].

Symptom	Cause	Measure
Stemi 305 cam is connected via Ethernet cable to a digital end device or a network router. The live image is not recognized in Labscope.	Ethernet DHCP is in wrong state.	<i>Switch Ethernet DHCP [▶ 18].</i>
	The Ethernet cable is broken or not plugged in correctly.	<ul style="list-style-type: none"> Reconnect the Ethernet cable. Replace the Ethernet cable.
	The Ethernet socket on the network router is defective.	Plug the cable into another Ethernet socket on the router.
	The Ethernet interface on the digital end device is defective.	Check this by connecting another digital end device .
Stemi 305 cam W body is connected via Wi-Fi. The live image is unstable or delayed.	The digital end device is not correctly connected to the network router	Check this by changing the Ethernet cable, by plugging the digital end device into another LAN socket on the router, by connecting the digital end device via Wi-Fi, or by changing the digital end device.
	<ul style="list-style-type: none"> Too high Wi-Fi load in the environment The Wi-Fi signal is too weak. 	<ul style="list-style-type: none"> Reduce the distance between Stemi 305 cam and the digital end device . Choose a Wi-Fi channel in the 5 GHz band. Connect the digital end device via Ethernet.
The status LED of Stemi 305 cam W body lights up continuously, but the Wi-Fi SSID is not visible in the Wi-Fi settings of the digital end devices around.	<ul style="list-style-type: none"> Stemi 305 cam is in Connect to existing WLAN mode. The Wi-Fi SSID was renamed (e.g. by another user). 	<ul style="list-style-type: none"> <i>Connect Stemi 305 cam W via Ethernet [▶ 17].</i> <i>Correct the Wi-Fi mode [▶ 21].</i> <p>Alternatively: <i>Reset Stemi 305 cam [▶ 27].</i></p>
	Stemi 305 cam W body has been configured to connect to an existing WLAN network on the configuration page, but is not detected in Labscope.	On the configuration page, the wrong Wi-Fi SSID was selected, or the password was not entered correctly.
The SSID of the WLAN network contains a dot, e.g.: "TP-Link_02.4G"		Rename the existing WLAN so that the SSID only consists of letters, digits, hyphens and underscores, e.g.: "TP-Link_02_4G"

Symptom	Cause	Measure
The live image of Stemi 305 cam W body appears twice in Labscope.	Stemi 305 cam W is double connected to a router (via Ethernet cable AND via the router's Wi-Fi network)	This is not an error. To remove one live image, the Ethernet cable can be disconnected, or the WLAN mode can be changed to "WLAN Access Point"
Multiple digital end devices are connected to the Wi-Fi network of Stemi 305 cam W body. On some of them, the live image does not appear, is not stable or delayed in Labscope.	The maximum Wi-Fi distance is exceeded or too many digital end devices are connected to the Wi-Fi network.	<ul style="list-style-type: none"> ▪ Reduce the distance between Stemi 305 cam and the digital end device. ▪ Choose a Wi-Fi channel in the 5 GHz band. ▪ Use a powerful external Wi-Fi router and connect Stemi 305 cam and all digital end devices to its Wi-Fi network. ▪ If feasible, connect the digital end devices via Ethernet.
Several Stemi 305 cam as well as digital end devices are correctly added to the same external Wi-Fi network. Some of the live images do not appear in Labscope, are not stable or delayed.	Too many Stemi 305 cam and digital end devices are connected to the external Wi-Fi router.	<ul style="list-style-type: none"> ▪ Choose a Wi-Fi channel in the 5 GHz band. ▪ Connect as many as possible Stemi 305 cam and digital end devices to the network via Ethernet. ▪ Add additional Wi-Fi access points to the Wi-Fi network. Group approx. 12 Stemi 305 cam and digital end devices around each Wi-Fi access point. ▪ Connect all Stemi 305 cam/digital end devices in the group to the Wi-Fi SSID of "their own" access point.
Software malfunctions		See Labscope manual.

8 Decommissioning and Disposal

This chapter contains information on the decommissioning and disposal of the microscope and its expansions/components or accessories.

8.1 Decommissioning

If the microscope and its components are not used for an extended period of time such as several months, they should be shut down completely and secured against unauthorized access.

DANGER

Electric injury due to live parts

When the microscope and its components are still switched on, coming in contact with live parts can lead to electric shock or burn.

- ▶ Switch off the microscope and its components prior to opening or cleaning.
- ▶ Disconnect live parts from the power supply.

- Procedure**
1. Switch off the microscope.
 2. Pull the power supply plug.

8.2 Transport and Storage

The following regulations must be observed before and during transport:

- The boxes must be secured during transport.
- Avoid rocking the boxes back and forth.
- Note the weight information on the package and on the shipping document.
- Where possible, the original packaging must be used for shipping or transport.

Allowable Temperature Allowable temperature during transportation to or between sites:

- Between -40 °C and 70 °C

Allowable temperature during storage at site:

- Between 10 °C and 40 °C
- Relative humidity less than 75 % at 35 °C

Info

24 hours before installation of the microscope it is required that the boxes are at recommended room temperature to avoid ingress of humidity, which is harmful to optical paths, and to ensure effective stability of the microscope during installation and testing.

8.3 Disposal

The microscope and its components must not be disposed of as domestic waste or through municipal disposal companies. They must be disposed of in accordance with applicable regulations (WEEE Directive 2012/19/EU). ZEISS has implemented a system for the return and recycling of devices in member states of the European Union that ensures suitable reuse according to the EU Directives mentioned.

ZEISS introduced a procedure for the return and recycling of the instruments within the member states of the European Union which ensures suitable recycling procedures conforming to the EU directives.

For more information on disposal and recycling please consult your ZEISS Sales & Service Partner. The microscope may not be disposed of in the household waste or through municipal waste disposal services. If the microscope is resold, the seller shall be obliged to inform the buyer that the microscope must be disposed of in accordance with the regulations.

The customer is responsible for decontamination.

8.4 Decontamination

A decontamination statement must be submitted before returning any used objects to the ZEISS location.

If reliable decontamination cannot be guaranteed, the hazard must be marked according to applicable regulations. In general, a well-visible warning sign must be affixed to the article itself and to the outside of the packaging, together with detailed information on the type of contamination.

9 Technical Data and Conformity

This chapter contains important technical data as well as information on the conformity.

9.1 Performance Data and Specifications

For detailed information on the performance data and specifications, see the instruction manual for Stemi 305.

Weight and Sizes	Main Components	Width (mm)	Depth (mm)	Height (mm)	Weight (kg)
	Stemi 305 cam body		165	215	235

Location requirements

The microscope may only be operated in closed rooms. The microscope should not be installed near radiators or windows with direct sunlight. The microscope must be placed securely on the table surface to prevent slipping and falling.

Compliance with the installation requirements of the microscope is the responsibility of the customer. The requested supplies have to be readily available at the time of installation.

Installation site	Exclusively inside buildings
Altitude	Max. 2000 m above sea level
Atmospheric pressure	Min. 800 hPa

Mains connection

	Value
Nominal AC voltage	L+N 100 VAC to 240 VAC \pm 10 % No line voltage conversion required!
Nominal frequency	50 / 60 Hz
Power consumption	max. 40 VA
Max. current	1.5 A
Protection class	IP20 (IEC 60529)
IEC earth class	Class II of IEC 61140
Overvoltage Category	II

Camera specification

Feature	Value
Sensor Type	1/3" CMOS sensor, color
Sensor Pixel Count	2560 px x 1440 px (horizontal x vertical) = 4 Megapixel
Pixel Size	2.0 μ m x 2.0 μ m
Active sensor area	5.44 mm x 3.07 mm
Image compression engine	H.264

Feature	Value
IP Live Stream and videos	1920 pixels x 1080 pixels (or 1280 pixels x 720 pixels)
Single images	2560 pixels x 1440 pixels
Frame rate live image	up to 30 fps
Wide dynamic range	>80 dB
Signal-to-noise ratio	>50 dB
White balance	AWB and various white balance modes
Image acquisition modes (via Lab-scope)	<ul style="list-style-type: none"> ▪ Normal snap (max. resolution) ▪ Fast snap (live resolution) ▪ Video record ▪ Time Lapse record ▪ Multi-channel (licensed module)
Connectivity	<ul style="list-style-type: none"> ▪ Ethernet ▪ Wi-Fi (only Stemi 305 cam W body)
Ethernet interface	RJ45 socket
Ethernet operation modes	<ul style="list-style-type: none"> ▪ Connect to LAN network mode (default) ▪ Direct 1:1 LAN connection mode
Wi-Fi interface (only Stemi 305 cam W body)	<ul style="list-style-type: none"> ▪ IEEE 802.11b/g/n: 2.4 GHz (frequency bands: 2412 MHz to 2462 MHz; RF output power: ≤ 17.86 dBm E.I.R.P.) ▪ IEEE 802.11a/n/ac: 5 GHz (frequency bands: 5150 MHz to 5250 MHz; RF output power: ≤13.84dBm E.I.R.P.)
Wi-Fi operation modes (only Stemi 305 cam W body)	<ul style="list-style-type: none"> ▪ As WLAN access point mode (default) ▪ Connect to existing Wi-Fi network mode
Wi-Fi range (only Stemi 305 cam W body)	5 m-15 m, depending on viewing direction and number of WLAN/Bluetooth equipment items within the range
SSID (only Stemi 305 cam W body)	configurable by the user

9.2 Applicable Standards and Regulations

Observe all general and country-specific safety regulations as well as applicable environmental protection laws and regulations. The microscope is in compliance with the requirements of the following regulations and directives:

2011/65/EU and delegated directive (EU) 2015/863	Directive 2011/65/EU of the European Parliament and of the Council of 8 June 2011 on the restriction of the use of certain hazardous substances in electrical and electronic equipment (RoHS), amended by Commission Delegated Directive (EU) 2015/863 of 31 March 2015
2014/30/EU	Directive 2014/30/EU of the European Parliament and of the Council of 26 February 2014 on the harmonization of the laws of the Member States relating to electromagnetic compatibility
2014/35/EU	Directive 2014/35/EU of the European Parliament and of the Council of 26 February 2014 on the harmonization of the laws of the Member States relating to the making available on the market of electrical equipment designed for use within certain voltage limits
EN 61010-1:2019	Safety requirements for electrical equipment for measurement, control, and laboratory use – Part 1: General requirements
EN IEC 61326-1:2021	Electrical equipment for measurement, control and laboratory use - EMC requirements - Part 1: General requirements

According to directive 2011/65/EU (RoHS) the microscope and its accessories have been classified as instrument category 9 (Monitoring and control instruments including industrial monitoring and control instruments). They also fall under 2012/19/EU (WEEE).

European and International Directives / Standards: For more information on ISO and CSA certificates or CE Declarations of Conformity, contact your ZEISS Sales & Service Partner.

Only applicable for the Stemi 305 cam W body:

2014/53/EU	Directive 2014/53/EU of the European Parliament and of the Council of 16 April 2014 on the harmonization of the laws of the Member States relating to the making available on the market of radio equipment and repealing Directive 1999/5/EC
S.I. 2017 No. 1206	STATUTORY INSTRUMENTS 2017 No. 1206 TELECOMMUNICATIONS The Radio Equipment Regulations 2017

9.3 Radio Approval

The Stemi 305 cam microscope with Wi-Fi and Ethernet camera may only be used if it has radio approval for your region.

If in doubt, contact a ZEISS service representative.

RF Exposure Information This device has been tested and meets applicable limits for Radio Frequency (RF) exposure.

Radio hazards for Canada The device for operation in the band 5150-5250 MHz is only for indoor use to reduce the potential for harmful interference to co-channel mobile satellite systems.

Les dispositifs fonctionnant dans la bande 5150-5250 MHz sont réservés uniquement pour une utilisation à l'intérieur afin de réduire les risques de brouillage préjudiciable aux systèmes de satellites mobiles utilisant les mêmes canaux.

10 Accessories and System Expansions

Only the following accessories may be used with the microscope as their safe use has been confirmed by ZEISS. Only original parts from ZEISS may be used. Check in advance whether your microscope can be retrofitted with a system expansion or accessories.

After installation or conversion it must be carefully checked whether the microscope and its system expansions/accessories are in a safe operational state and whether unused ports are closed. For details and safety measures refer to the associated documents.

Info

For additional information and detailed descriptions, refer to further applicable documents or ask your ZEISS Sales & Service Partner.

Name	Description/Info
Front optics	The following optics are available: <ul style="list-style-type: none"> ▪ Front Optics 3 0.5x FWD 185 mm ▪ Front Optics 3 0.75x FWD 128 mm ▪ Front Optics 3 1.5x FWD 56 mm ▪ Front Optics 3 2.0x FWD 43 mm
Dust protection glass	The following protection glass is available: <ul style="list-style-type: none"> ▪ Dust Protection Glass M52/M49
Pol analyzer	The following analyzer is available: <ul style="list-style-type: none"> ▪ Analyzer M49/52 rotatable
Eyepieces	The following eyepieces are available: <ul style="list-style-type: none"> ▪ Eyepiece 16x/14 Br foc ▪ Eyepiece PI 16x/16 Br foc ▪ Eyepiece W 25x/10 Focusing w/ Eyecup
Eyepieces with reticles	The following eyepieces with reticles are available: <ul style="list-style-type: none"> ▪ Eyepiece PI 10x/23 Br foc w/micrometer for Stemi 305/508 ▪ Eyepiece PI 10x/23 Br foc w/crossline for Stemi 305/508 ▪ PI 16x/14 Br foc w/micrometer for Stemi 305/508
Eyecup	The following eyecup is available: <ul style="list-style-type: none"> ▪ Folding Eyecup
Stage micrometers	The following light stage micrometers are available: <ul style="list-style-type: none"> ▪ Stage Micrometer 25+50/10, f/Stemis ▪ Stage Micrometer, 25+50/10, calibrated
LED stands	The following LED stands are available: <ul style="list-style-type: none"> ▪ Stand K MAT ▪ Stand K EDU ▪ Stand K LAB

Name	Description/Info
Mechanic stands w/o LEDs	The following mechanic stands are available: <ul style="list-style-type: none"> ▪ Stand K ▪ Stand M ▪ Stand N with Column 32/450 mm
required for Stand N	<ul style="list-style-type: none"> ▪ Stemi Mount Column 32 with Drive
Illuminators K LED	The following illuminators are available: <ul style="list-style-type: none"> ▪ Spot Illuminator K LED ▪ Double Spot Illuminator K LED ▪ Ring Illuminator K LED segmentable
for spot/double spot K LED (optional)	<ul style="list-style-type: none"> ▪ Polarizer Spot K LED
for stand-alone use of ring light K LED	<ul style="list-style-type: none"> ▪ Controller K LED
Stages (d=84 mm for stands K/M/N)	The following stages are available: <ul style="list-style-type: none"> ▪ Gliding Stage f/ Stemis ▪ Stage Ball & Socket f/ Stemis ▪ Rotating Stage Stemi
for rotating stages	<ul style="list-style-type: none"> ▪ Polarizer S f/ Stage 455120 ▪ Lambda Plate in Slider

Revision History

Revision	Date of Issue	Introduced Modifications
2	08/2024	<ul style="list-style-type: none">Change of address of the manufacturerEditorial rework
1	01/2024	<ul style="list-style-type: none">Initial creation

Tab. 1: Revision History

Glossary

DHCP

Dynamic Host Configuration Protocol

Wi-Fi

Wireless Fidelity

ZEISS Sales & Service Partner

The Sales & Service Partner is generally in the field for customer support in a regional area and / or a clearly defined customer group.

ZEISS service representative

Specially trained service expert, either ZEISS staff or authorized service partner of ZEISS.

Index

A

Accessories 39

C

Cleaning
 Water-soluble contaminations 28
 Contamination 34
 Controls 14

D

Decontamination 34
 Disposal 33

G

General Safety Information 9

H

Hazards 12
 Prevention 12

I

Improper use 9

M

Mains connection 35
 Maintenance 28

O

Operation
 Prerequisites 18
 Optional system expansions 39
 Installation 39

P

Performance data 35
 Prerequisites
 Operation 18

R

Radio approval 38
 Requirements
 for Operators 9

S

Safe Operating Condition 10
 Safety 9
 Factory settings 27
 Shutdown 33

Software 8
 Spare parts 10

T

Troubleshooting 30

W

Warning
 labels 12
 lights 12
 Weight and Sizes 35

Z

ZEISS
 Portal 8
 Service agreements 28



authorized dealer:
Pulch + Lorenz microscopy
Am Untergrün 23, D-79232 March
tel: 07665 9272-0
fax: 07665 9272-20
mail: kontakt@pulchlorenz.de
web: pulchlorenz.de

Carl Zeiss Microscopy GmbH
Carl-Zeiss-Promenade 10
07745 Jena
Germany

phone: +49 1803 33 63 34
fax: +49 3641 64 3439

info.microscopy.de@zeiss.com
www.zeiss.com/microscopy